

FLOAT AND DISPLACER LEVEL SWITCHES

Type: DA, DB and DF



Bypass Level Switch type DA



Bypass Level Switch type DB



Displacer level switch type DF

Technical Information

2014

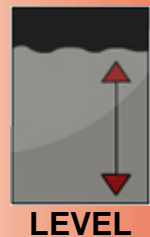

Intra-Automation GmbH
Technical Information

© 2014 Intra-Automation GmbH
Printing errors and technical changes reserved.
For all comments regarding this brochure, please contact info@intra-automation.de

Chapt.	Content	Page
1	Level Switches series DA, DB (Float operated)	4
1.1	Functional principle	4
1.2	Design	4
1.3	Applications	5
1.4	Technical data	5
1.5	Order code for DA / DB	6
2	Level Switches series DF (Displacer operated)	8
2.1	Functional principle	8
2.2	Design	8
2.3	Special versions	10
2.4	Order code for DF standard design	11
2.5	Order code for DF special design	13

1. Level Switches series DA, DB (Float operated)

1.1 Functional principle

The level of liquid present in a vessel is checked by the float being inside the main body, the chamber, of the Level Switch. When level rises up to the preset height, the float makes the output device trip (trip on rise); when level comes down again and exceeds the preset height, the float makes the output device come back to the initial position (reset on fall); between the set and reset heights there is always a gap, named differential : see below. The inverse function is available too : Trip on fall and Reset on rise. The output device can be electric or pneumatic, is snap action and is placed in the housing. Differently from DA, the type DB is provided with inspection flanges, allowing to open the instrument and to clean it from possible residues of the liquid under control.

The level switches meet the PED and ATEX standards.

1.2 Design

	Side-Side mounting Fig. A	Side-Bottom mounting Fig B	Sleeve mounting (thread or welded) Fig C/D
Type DA			
Type DB			

Dimensions:

	M (mm)		H (mm)			L (mm)	
	DA, DB	DA	DA	DB	DA	DA, DB	DA
pressure rating (ANSI)	150...600	1500...2500	150...600	150...600	1500...2500	150...600	1500...2500
Fig. A	178	178	660	710	750	195	220
Fig. B	350	400	730	780	800	195	220
Fig. C	178	178	660	710	660	90	115
Fig. D	250	300	630	680	680	90	115

(Special versions on request)

1.3 Applications

Alarm for Max and Min level, control of pumps on vessels including simple water or chemical corrosive or toxic liquids, under pressures and temperatures also very high or very low; for liquids with specific gravity from 500kg/m³ up.

1.4 Technical data

1.4.1 Body

Materials	:	Carbon steel ASTM A106B, stainless AISI 304, or AISI 316.
Size	:	Ø _{outer} 4" (114,3mm), different thickness as per ASME standards.
Rating	:	ANSI 150, 300, 600, 1500, 2500 psi.
Bottom	:	The Side-Side Switches have drain hole ¾" NPT-F threaded (upon request, ½" NPT-F or 1" NPT-F), with or without accessories (plugs, valves, etc).
Inspection flanges	:	Ø _{outer} 3" in the ratings ANSI 150 to 600 psi (face RF) Ø _{out.} 2½" in the ratings ANSI 1500 to 2500 psi (face RJ).

1.4.2 Connections to vessel

Materials	:	Carbon steel ASTM A105N, stainless AISI 304, or AISI 316.
Flanges (ANSI)	:	150 to 2500 psi, Ø 1 to 2"
Flanges (DIN)	:	PN 10 to 100, DN 25 to 100
Sleeves	:	Threaded or socked welding
Mounting	:	Side-Side or Side-Bottom.
C/C-distance M:	:	As per table page 4, other distances on request

1.4.3 Housing

Aluminium cast, in electric or pneumatic version:

- ◆ With 1 or 2 microswitches SPDT with simultaneous action
size : Ø155×200mm, flame-proof EEx dc IIC T6;
1 hole for electric connection : ¾" NPT-F threaded (or ½" NPT-F)
housing-holder height :
- 80mm for temperatures of -20/+180°C
- 145mm for higher or lower temperatures.
- ◆ With 1 pneumatic valve On/Off/Vent; Ø125×180mm, water-proof;
3 holes for air connection ¼" NPT-F : inlet, outlet and vent;
housing-holder height :
- 70mm for temperatures of -20/+180°C
- 130mm for higher or lower temperatures.

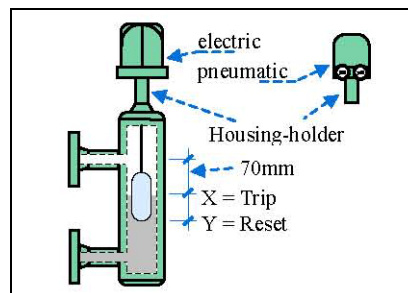

1.4.4 Differential

The Switch trips when level reaches the X height and resets when comes back to Y height (or on the contrary), as per the side sketch.

Usually the X point is fixed at 70mm below the top connection, and between X and Y there is a differential of about 30-65mm (it changes on basis of the specific gravity of liquids); but, upon request, such heights and differentials can be made different too.

1.4.5 Outer finish

Switches in carbon steel have the standard painting so realized : first coat in epoxy resin, and outer coat in green polyurethane resin; suitable for corrosive marine environments and tropical climates. Switches in stainless steel are polished and left bare.

1.5 Order code for DA / DB

Code	Description
1. Type of level switch	
DA-	Level switch without inspection flanges
DB-	Level switch with inspection flanges
2. Mounting	
L L	Side-Side
L F	Side-Bottom
3. Mounting parts	
D	Flanges DIN
F	Flanges ANSI with RF-face
J	Flanges ANSI with RJ (Ring Joint)-face
N	Sleeves, female threaded, NPT-F
P	Sleeves, male threaded, NPT-M
S	Sleeves, socket welded
4. Pressure rating	
1 5	ANSI 150 lbs
3 0	ANSI 300 lbs
6 0	ANSI 600 lbs
M 5	ANSI 1500 lbs
D 5	ANSI 2500 lbs
1 0	PN10
1 6	PN16
2 5	PN25
4 0	PN40
6 4	PN64
C 1	PN100
5. Connection size	
C	1"
D	1 1/2"
E	2"
3	DN25
4	DN40
5	DN50
-	
6. Center to center distance	
M	□ □ □ Please replace □ □ □ by the c to c distance in mm
-	
7. Body and connection material	
A C	CS
A 4	304SS
A 6	316SS
-	
8. Drain	
N N	Side-bottom → no drain possible
A	1/2"NPT-F
B	3/4"NPT-F
C	1"NPT-F
	N with drain, no accessory
	T with drain, plugged (mat. as body)
	R with drain, with valve
	S with drain, with valve and plug
-	

□ □ □ □ □ - □ □ □ □ □ - □ □ □ □ □ - □ □ □ □ □ -

Coding (Continuation)

						-					-			-			-		
--	--	--	--	--	--	---	--	--	--	--	---	--	--	---	--	--	---	--	--

9. Housing			
Electric of pneumatic output			
<input type="checkbox"/>	A		6A/24VDC, silver contact
<input type="checkbox"/>	B		6A _{res} /5A _{ind} /30VDC, silver contact
<input type="checkbox"/>	Q		1mA/5VDC (min); 1A/125VDC (max); gold contact
<input type="checkbox"/>	R		sealed in inert gas, 3A _{res} /1,5A _{ind} /30VDC, silver contact
<input type="checkbox"/>	Z		sealed in inert gas, 1mA/5VDC (min); 0,5A/30VDC (max); gold contact
1	P	A	1 pneumatic valve ON-OFF, opens air when level rises, with 2 manometers
1	P	C	1 pneumatic valve ON-OFF, closes air when level rises, with 2 manometers

Please replace by the number of switches (SPDT with simultaneous action)

Hole for electric connection			
	A		1/2"NPT-F
	B		3/4"NPT-F

Housing holder			
		S	Standard: -20/+180°C
		H	High temp.: +181/+450°C with fins
		L	Low temp.: -21/-60°C without fins

						-					-			-			-		
--	--	--	--	--	--	---	--	--	--	--	---	--	--	---	--	--	---	--	--

Standard options printed in **BOLD** letters.

Additionally to the coding, the following information is necessarily needed:

Fluid upper:	_____	Density:	upper:	_____	kg/m ³
lower	_____		lower:	_____	kg/m ³
Temperature Min.:	_____ °C	Operating:	_____ °C	Max.:	_____ °C
Pressure Min.:	_____ bar*	Operating:	_____ bar*	Max.:	_____ bar*

*for easy converting: 15 bar ~ 15 atm ~ 15 kg/cm² ~ 15 kPa ~ 15 MPa

Footnotes:

- ◆ The inspection flanges on DB would be out of acceptable proportions in comparison with chamber, and so for such high pressures we suggest to adopt DA.
- ◆ Micro A : also 6A resistive – 250Vac; temperatures of : -25/+85°C.
- ◆ Micro B : also 15A resistive – 3A inductive – 250Vac; temperatures of : -25/+80°C.
- ◆ Micro Q : also 1A – 125Vac, but is recommended for very low electric loads (e.g. insulating barriers with few mA and V); temperatures of : -55/+85°C.
- ◆ Micro R : also 1A resistive – 0,8A inductive – 220Vac; temperatures of : -55/+150°C.
- ◆ Micro Z : recommended for very low electric loads (e.g. insulating barriers with few mA and V); temperatures of : -55/+150°C.

2. Level Switches series DF (Displacer operated)

2.1 Functional principle

The level of the liquid present in a vessel is checked by one or more displacers (i.e. floats correctly ballasted) hung on a metallic rope. When level rises up to the preset height, the displacer makes the output device trip (trip on rise); when level comes down again and exceeds the preset point, the displacer makes the output device come back to the initial position (rest on fall); between the trip and reset points there is always a gap, named differential : see below. The inverse function is available too : Trip on fall and Reset on rise. The output device can be electric or pneumatic, is snap action and is placed in the housing. All of them are mounted on top vessel.

Several types of Switches are available, with some elements in common.

- ◆ Body and flange in the ratings ANSI 150, 300, 600psi, in carbon steel ASTM A106B (body) and ASTM 105N (flange), stainless AISI 304, or stainless AISI 316. Flange : ANSI or UNI/DIN standards
- ◆ Displacer and rope (L=1÷10m) in stainless AISI 316. The displacer can be fixed on the rope at the desired height, decided by the user himself.
- ◆ For liquids with specific gravity from 500kg/m³ up.
- ◆ Housing and housing-holder : as described below 110
- ◆ Outer finish : green, for marine and tropical climates,

The Switches meet the PED and ATEX standard

2.2 Design

DF1 – It is provided with 1 displacer and 1 output, electric or pneumatic.

- ◆ The output trips when liquid rises (or falls) up to displacer and resets when falls (or rises) of 65 ±15mm (differential not changeable).
- ◆ Output : - electric (1 or 2 micro switches SPDT with simultaneous action : within Ø155×200mm housing); - pneumatic (1 valve ON-OFF, in Ø125×180mm housing).
- ◆ Use : Alarm for Max or Min level, control of loading pump, etc.

DF2A – It is provided with 2 displacers and 1 output, electric or pneumatic.

- ◆ The output trips when liquid rises up to the displacer A, and resets when falls up to the displacer B (or on the contrary).
- ◆ The differential can be decided by the same installer : he will fix the displacer A at the trip height, and B at the reset height; in this way the gap between the two displacers corresponds to the wished differential. The minimum differential is 160mm, with the 2 blocks placed under B.
- ◆ Output : - electric (1 or 2 micros SPDT with simultaneous action : in Ø155×200mm housing); - pneumatic (1 valve ON-OFF, in Ø125×180mm housing).
- ◆ Use : Loading of vessel, to stop a loading pump when level rises up to the displacer A, and to start it again when level falls to the displacer B.

DF2B – It is provided with 2 displacers and 2 electric outputs.

- The output 1 is activated by displacer A placed at L₁, while the output 2 is activated by displacer B placed at L₂. The two trips are independent and depend only on the heights at which the displacers are fixed. Each of them resets with differential of 65 ±15mm.
- DF2B operates as if it were composed by two DF1.
- Each output : 1 or 2 micros SPDT with simultaneous action : within Ø155×200mm housing.
- Use: Alarm for Max or Min level. It operates as composed by two DF1.

DF3 : They are provided with 3 displacers. and various electric outputs (each output has 1 or 2 micros SPDT with simultaneous action)

DF3A – The output 1 is activated by the displacer A placed at L₁ (can be used as Max level alarm); the output 2 is activated by the displacer B placed at L₂ 125 (trip) and by the displacer C placed at L₃ (reset). It can be used to control the loading/unloading pump. In Ø155×200mm housing. It operates as if it were composed by one DF1 + one DF2A

DF3B – The output 1 is activated by displacers A placed at L₁ (trip) and B placed at L₂ (reset), and can be used to load/unload a vessel. The output 2 is activated by displacer C placed at L₃, and can be used as Min level alarm. In Ø155×200mm housing. It operates as if it were composed by a DF2A + a DF1.

DF3C – It is provided with 3 displacers and 3 independent electric outputs. Within Ø155x250mm housing. It operates as if it were composed by three DF1.

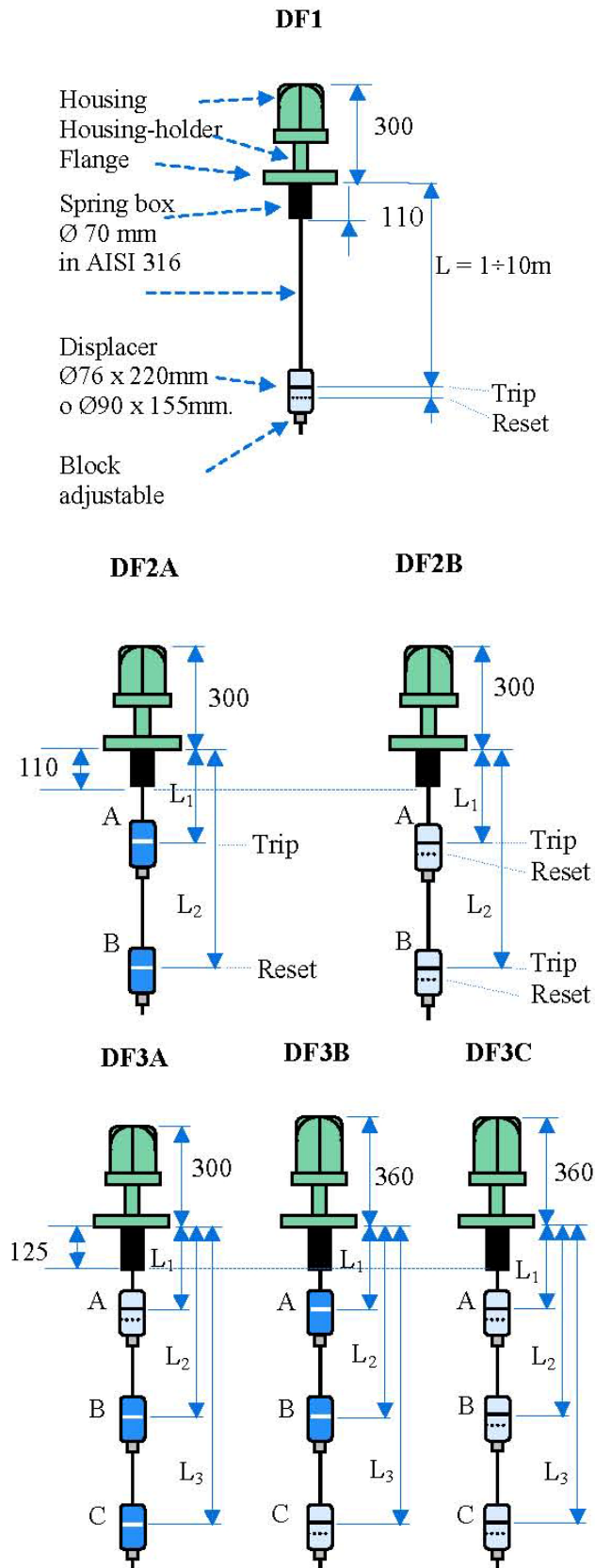

2.3 Special versions

DF1 for floating cover, in TG version

When switches are mounted on vessels in which the liquid is protected by a floating cover, displacer is replaced by a solid body with similar weight as displacer's. When body is lifted by floating cover, it makes output device trip; the output device can be electric or pneumatic, and is placed within housing.

APPLICATIONS. Trip for High or Low level, with the same performances as DF1 type.

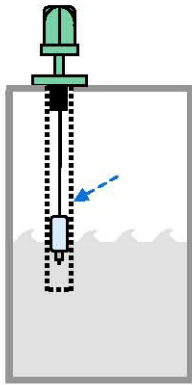
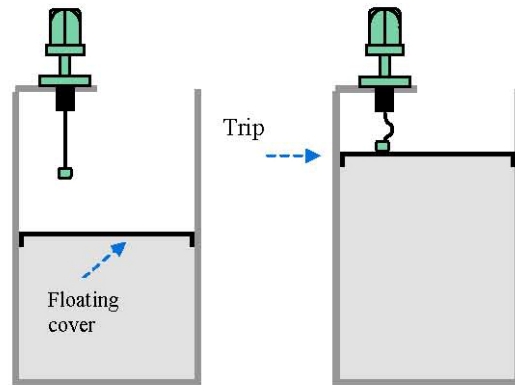

DF1, DF2A-DF2B, DF3A-DF3B-DF3C with damping tube, in TC version

When switches are mounted on vessels containing turbulent liquids, We recommend to protect displacers within a damping tube, to avoid untimely trips. Usually such a tube is procured and mounted by the same vessel installer, or, upon request, can be supplied by Domizi Snc already assembled on the Switch.

APPLICATIONS. Trip for High or Low level, pump On/Off turning, as for all the DF types.

DF1, DF2A-DF2B, DF3A-DF3B-DF3C in DB version

When a Switch is mounted on a side of vessels and shall carry out performances being impossible with DB Switch (e.g. pump On-Off turning with very wide differentials), We propose to use a DF Switch included within a DB body. In this way you get an instrument with performances being typical of DF and with mechanical look of DB, both as body and as connection/inspection flanges.

APPLICATIONS. Trip of High or Low level, pump On/Off turning, as for all the DF types.

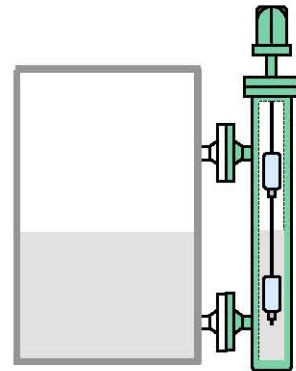

2.4 Order code for DF standard design

Code	Description
1. Type of level switch	
DF1	Level switch with one displacer
DF2A	Level switch with two displacers
DF2B	Level switch with two displacers
DF3A	Level switch with three displacers
DF3B	Level switch with three displacers
DF3C	Level switch with three displacers
-	
2. Vessel connection flange	
D	Flange acc. DIN
F	Flange acc. ANSI with RF face
J	Flange acc. ANSI with RJ (ring joint) face
2.1 Pressure rating	
1 5	ANSI 150 lbs
3 0	ANSI 300 lbs
6 0	ANSI 600 lbs
1 0	PN10
1 6	PN16
2 5	PN25
4 0	PN40
2.2 Flange size	
G	3" [with displacer Ø76 x 220 mm]
H	4" [with displacer Ø90 x 150 mm]
6	DN80 [with displacer Ø76 x 220 mm]
7	DN100 [with displacer Ø90 x 150 mm]
-	
3. Material body and flange	
A C	CS
A 4	304SS
A 6	316SS
-	
4. Housing	
4.1 Electric or pneumatic output	
<input type="checkbox"/> A	6A/24VDC, silver contact
<input type="checkbox"/> B	6A _{res} /5A _{ind} /30VDC, silver contact
<input type="checkbox"/> Q	1mA/5VDC (min); 1A/125VDC (max); gold contact
<input type="checkbox"/> R	sealed in inert gas, 3A _{res} /1,5A _{ind} /30VDC, silver contact
<input type="checkbox"/> Z	sealed in inert gas, 1mA/5VDC (min); 0,5A/30VDC (max); gold contact
1 P A	1 pneumatic valve ON-OFF, <u>opens</u> air when level rises, with 2 manometers
1 P C	1 pneumatic valve ON-OFF, <u>closes</u> air when level rises, with 2 manometers
Please replace <input type="checkbox"/> by the number of switches	
4.2 Hole for electric connection	
A	½"NPT-F
B	¾"NPT-F
4.3 Housing holder	
S	Standard: -20/+180°C
H	High temp.: +181/+450°C with fins
L	Low temp.: -21/-60°C without fins
-	

Coding (Continuation)

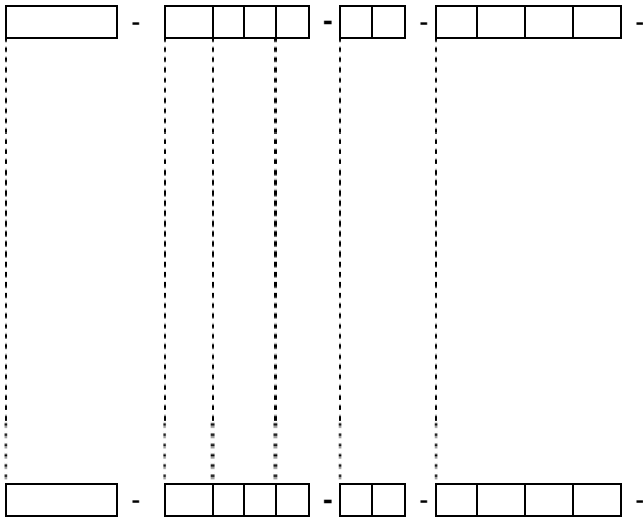

5. Rope length:	
1	1 m
2	2 m
3	3 m
4	4 m
5	5 m
6	6 m
7	7 m
8	8 m
9	9 m
D	10 m

Standard options printed in **BOLD** letters.

Additionally to the coding, the following information is necessarily needed:

Fluid upper: _____ Density: upper: _____ kg/m³
 lower _____ lower: _____ kg/m³
 Temperature Min.: _____ °C Operating: _____ °C Max.: _____ °C
 Pressure Min.: _____ bar* Operating: _____ bar* Max.: _____ bar*

*for easy converting: 15 bar ~ 15 atm ~ 15 kg/cm² ~ 15 kPa ~ 15 MPa

Footnotes:

- ◆ Micro A : also 6A resistive – 250Vac; temperatures of : -25/+85°C.
- ◆ Micro B : also 15A resistive – 3A inductive – 250Vac; temperatures of : -25/+80°C.
- ◆ Micro Q : also 1A – 125Vac, but is recommended for very low electric loads (e.g. insulating barriers with few mA and V); temperatures of : -55/+85°C.
- ◆ Micro R : also 1A resistive – 0,8A inductive – 220Vac; temperatures of : -55/+150°C.
- ◆ Micro Z : recommended for very low electric loads (e.g. insulating barriers with few mA and V); temperatures of : -55/+150°C.

2.5 Order code for DF special design

Code	Description
1. Type of level switch	
DF1	Level switch with one displacer
DF2A	Level switch with two displacers
DF2B	Level switch with two displacers
DF3A	Level switch with three displacers
DF3B	Level switch with three displacers
DF3C	Level switch with three displacers
-	
2. Special version	
T G	Switch for floating cover
T C	Switch with damping tube
D B	Switch DF in the body of DB (see herein after)
-	
3.1 Vessel connection flange (Designs TG and TC)	
D	Flange acc. DIN
F	Flange acc. ANSI, flange face RF
J	Flange acc. ANSI, flange face RJ (ring joint)
3.2 Pressure rating	
1 5	ANSI 150 lbs
3 0	ANSI 300 lbs
6 0	ANSI 600 lbs
1 0	PN10
1 6	PN16
2 5	PN25
4 0	PN40
3.3 Flange size	
G	3" [recommended for DB-design]
H	4"
6	DN80
7	DN100
-	
4. Material body and flange	
A C	CS
A 4	304SS
A 6	316SS
-	
5. Housing	
5.1 Electric or pneumatic outputs	
<input type="checkbox"/> A	6A/24VDC, silver contact
<input type="checkbox"/> B	6A _{res} /5A _{ind} /30VDC, silver contact
<input type="checkbox"/> Q	1mA/5VDC (min); 1A/125VDC (max); gold contact
<input type="checkbox"/> R	sealed in inert gas, 3A _{res} /1,5A _{ind} /30VDC, silver contact
<input type="checkbox"/> Z	sealed in inert gas, 1mA/5VDC (min); 0,5A/30VDC (max); gold contact
1 P A	1 pneumatic valve ON-OFF, <u>opens</u> air when level rises, with 2 manometers
1 P C	1 pneumatic valve ON-OFF, <u>closes</u> air when level rises, with 2 manometers

Please replace by the number of switches

- - - -

Coding (Continuation)

5.2 Hole for electric connection			
	A		1/2"NPT-F
	B		3/4"NPT-F
5.3 Housing-holder			
		S	Standard: -20/+180°C
		H	High temp.: +181/+450°C with fins
		L	Low temp.: -21/-60°C without fins

6. Rope length	
1	1 m
2	2 m
3	3 m
4	4 m
5	5 m
6	6 m
7	7 m
8	8 m
9	9 m
D	10 m
-	

* The coding for TG and TC ends here, for version DB, please add the below coding.

Additional coding for DB-design

Code	Description
7. Mounting	
L	L Side-Side
L	F Side-Bottom
7.1 Tank connection of bypass vessel (mounting parts)	
D	Flanges DIN
F	Flanges ANSI with RF-face
J	Flanges ANSI with RJ (Ring Joint)-face
N	Sleeves, female threaded, NPT-F
P	Sleeves, male threaded, NPT-M
S	Sleeves, socket welded
7.2 Size mounting parts	
C	1"
D	1 1/2"
E	2"
3	DN25
4	DN40
5	DN50
-	
8. Center to center distance of tank connections	
M	□□□□ Please replace □□□□ by the c to c distance in mm
-	
9. Drain	
N	N
A	
B	
C	
	N
	T
	R
	S

Standard options printed in BOLD letters.

Coding (Continuation)

Additionally to the coding, the following information is necessarily needed:

Fluid	upper:	_____	Density:	upper:	_____	kg/m ³
	lower	_____		lower:	_____	kg/m ³
Temperature	Min.:	_____ °C	Operating:	_____ °C	Max.:	_____ °C
Pressure	Min.:	_____ bar*	Operating:	_____ bar*	Max.:	_____ bar*

*for easy converting: 15 bar ~ 15 atm ~ 15 kg/cm² ~ 15 kPa ~ 15 MPa

Footnotes:

- ◆ Micro A : also 6A resistive – 250Vac; temperatures of : -25/+85°C.
- ◆ Micro B : also 15A resistive – 3A inductive – 250Vac; temperatures of : -25/+80°C.
- ◆ Micro Q : also 1A – 125Vac, but is recommended for very low electric loads (e.g. insulating barriers with few mA and V); temperatures of : -55/+85°C.
- ◆ Micro R : also 1A resistive – 0,8A inductive – 220Vac; temperatures of : -55/+150°C.
- ◆ Micro Z : recommended for very low electric loads (e.g. insulating barriers with few mA and V); temperatures of : -55/+150°C.

Besides the products covered by this brochure, Intra-Automation GmbH also manufactures other high-quality and high precision instruments for industrial measurement tasks. For more information, please contact us (contact details on the backside of this brochure).

Flow measurement on the differential pressure principle:

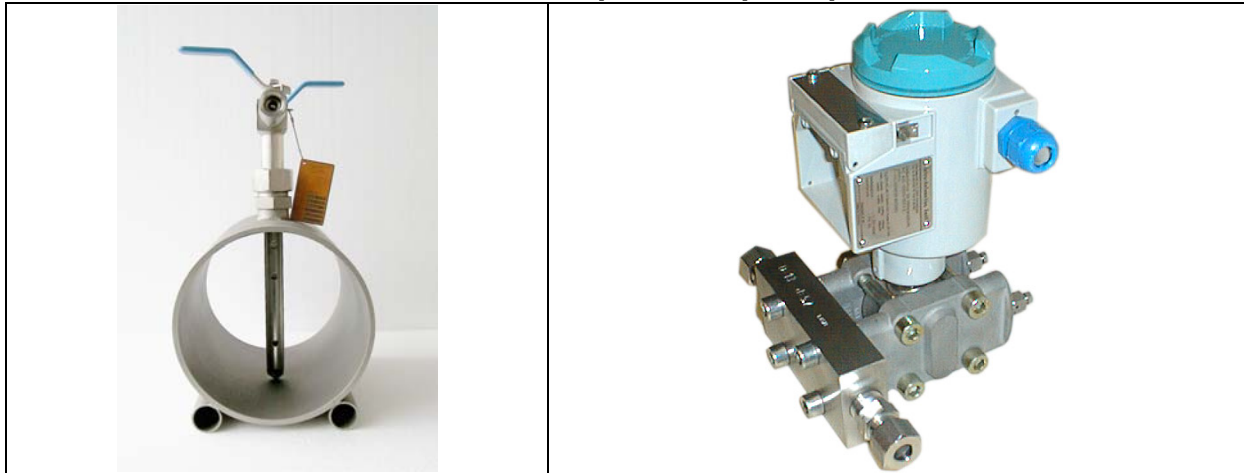

Itabar-Flow-Sensor (pitot tube)

Orifice Assembly

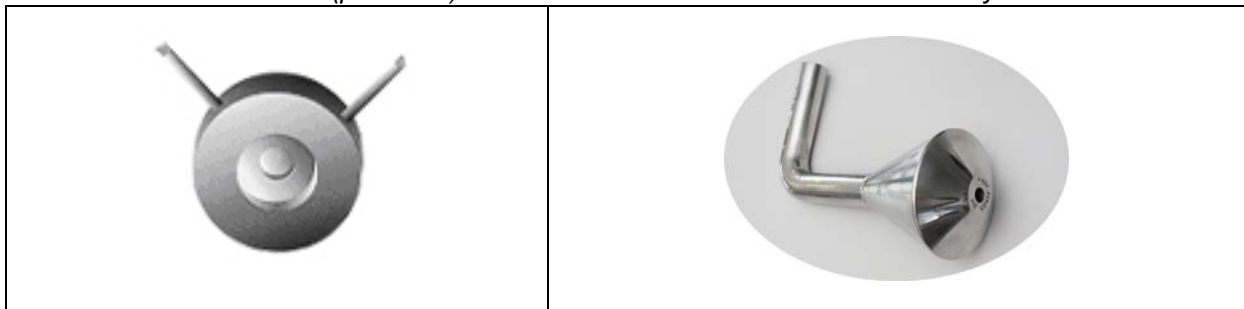

Div. types of orifice flow measurements

Cone Flow Meter



Flow Nozzle

Venturi Tube



Wedge Flow Meter

Bypass level measurement*ITA mag. level gauge**ITA-TG Transparent level gauge**ITA-RG Reflex level gauge**ITA-GG Tubular level gauge*

The Intra-Automation product line is also completed by all kinds of electronic accessories like switches and transmitters. Also, it is changing from time to time in order to get completed.

To be up-to-date, please frequently visit our homepage www.intra-automation.com for your information.



INTRA-AUTOMATION

MESS- UND REGELINSTRUMENTE / MEASUREMENT AND CONTROL



TÜVRheinland®
CERT
ISO 9001

International Headquarters:

Intra-Automation GmbH
Otto-Hahn-Str. 20
41515 Grevenbroich
GERMANY

☎ +49 – (0) 21 81 / 7 56 65-0

☎ +49 – (0) 21 81 / 6 44 92

✉ info@intra-automation.de

🌐 www.intra-automation.com

Sales Office for the BENELUX:

B.V. Intra-Automation HTP
PO Box 10
4730 AA Oudenbosch
THE NETHERLANDS

☎ +31 – (0)165 – 32 22 01

☎ +31 – (0)165 – 32 29 70

✉ info@intra-automation.nl